Training Papers

Distillation and Environment

Contents

1.	Introduction
2.	Optimal Parameters
2.1.	Selection of vacuum and temperature
2.2.	Choice of set-up and equipment
2.3.	Physical processes during distillation
3.	Summary



Progress built on tradition

Copyright© Rosemary Hoegger; **BÜCHI** Labortechnik AG 1997,1998

English, Version B (11 pages)

Order No.

Distillation and Environment

97747

1**Introduction**

Over 80% of all laboratory users of distillation apparatus are interested first and foremost in the residue that remains after evaporation, the distilled solvent is an unimportant side product.

For the environmentalist, however, this side product assumes great importance. World-wide there are around 200,000 rotary evaporators and just as many static glass systems in use. Taking a distillate loss rate of 10%, this adds up to an immense amount of 160,000 litres of solvent entering our water and the air we breathe each and every day (400,000 sets of apparatus x 1 litre of solvent per hour x 4 working hours per day x 10% loss).

The environment-conscious user thus has every justification to ask:

- What are the reasons for these solvent losses?
- How can solvent be condensed under controlled conditions?
- What is the optimum distillation set-up?

2**Optimal Parameters**

Solvent recovery rates of over 99% can be achieved. That's quite possible without any significant loss of time or use of expensive special apparatus.

The following parameters have to be noticed:

- Selection of solvent- and product-specific temperature and pressure conditions
- Correct choice of set-up and equipment
- Proper understanding of the physical processes involved in distillation

2.1**Vacuum / boiling temperature / cooling water temperature**

Nowadays one usually distills under vacuum. Due to the lower boiling point the product is treated more gently. The distillation capacity increases. Boiling point and system pressure are mutually dependent. It is only possible to select **one** of these parameters. Is, for instance, the pressure selected, the temperature will adjust itself accordingly.

Example:

A boiling point of 40°C is required = 175 mbar
Ethanol:
or with a lab vacuum of 20 mbar = boiling point of 4°C

This relationship is put to practical use in controlling the condensation cycle in the condenser and in specifying the maximum boiling temperature in the evaporating flask. If a low boiling temperature is important in order to guard the product from loads, the system pressure and the cooling water temperature must be set accordingly:

Example:

Water with an organic product permits a maximum boiling point of 24°C

→ requires system pressure: 30 mbar
 → required cooling water temperature: 4°C
 (in accordance with the rule of thumb: cooling water/boiling point $\Delta t = 20^\circ\text{C}$)

Picture 1: Dependence of boiling point (T) and system pressure (p)

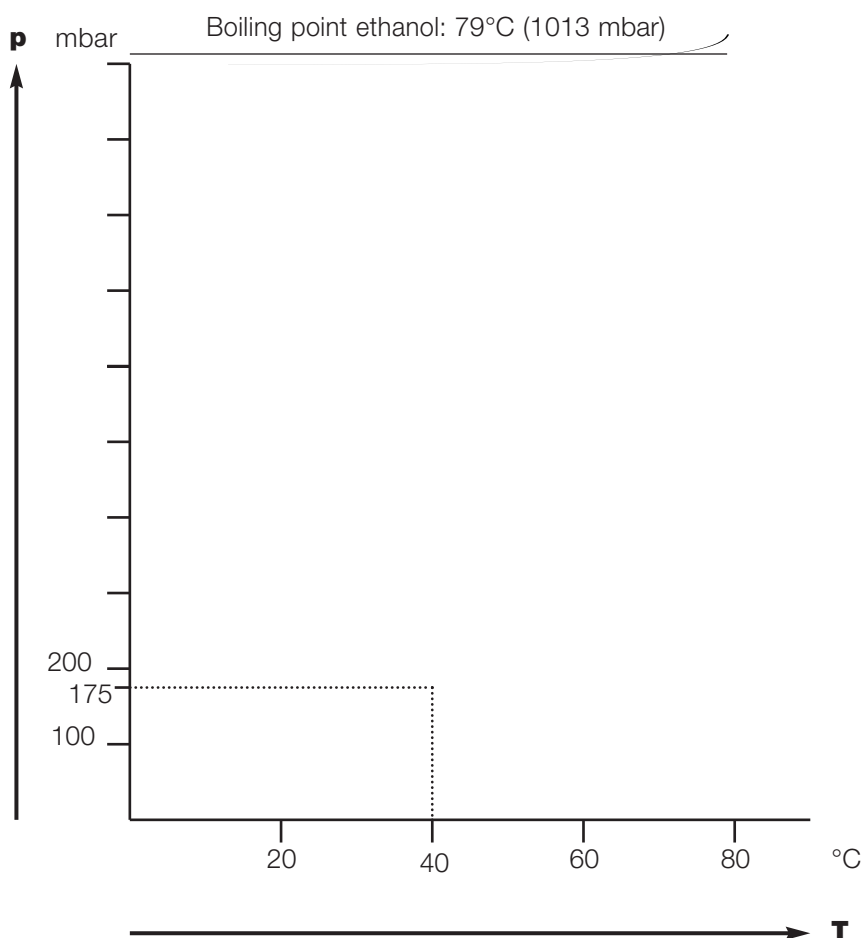

2.2 Choice of set-up and equipment

Condensation surface of the condenser

Energy is imparted to the solvent in order to transform it into the vaporous state; during the condensation cycle this energy has to be removed again within the same length of time.

Picture 2:

Vapor transport

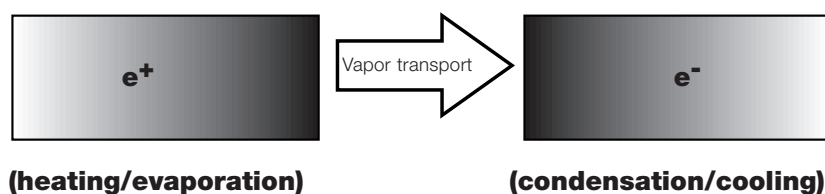

Büchi recommend a Δt of 20°C (boiling temperature/cooling water) to carry off the accumulated energy efficiently.

Picture 3:

Minimization of the carrier air flow

Carrier air flow

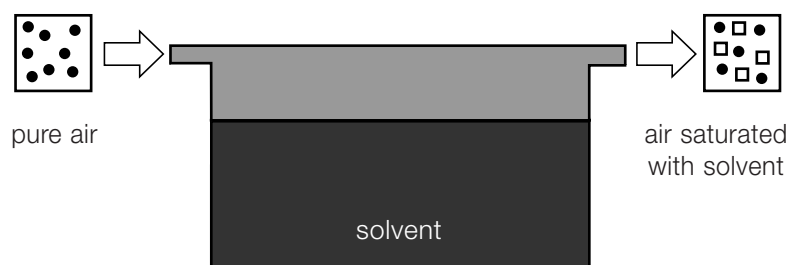

Every partial volume of pure air that is drawn or channelled into the system - consciously or unconsciously - has to be evacuated again in order to maintain the system pressure. But now the air is saturated with solvent! In other words, this air flow acts as the actual carrier medium and is a major contributor to the loss of solvent. Two factors demand particular attention with a view to minimizing the flow of carrier air: Sealing of the glass assembly, and the type of vacuum control.

Glass assembly

With modern radial sealing systems made of PTFE/rubber and high-precision vapor ducts (tolerances of +/- 0.2 mm) there is no difficulty in achieving leakage rates of less than 2 mbar/min from a rotary evaporator. As with all types of glass assemblies, whether static or rotary, it is essential to use original spare parts. The respective manufacturer is the only supplier who can and will guarantee exactly fitting ground joint connections and seals.

Picture 4: Possible weak points in the system

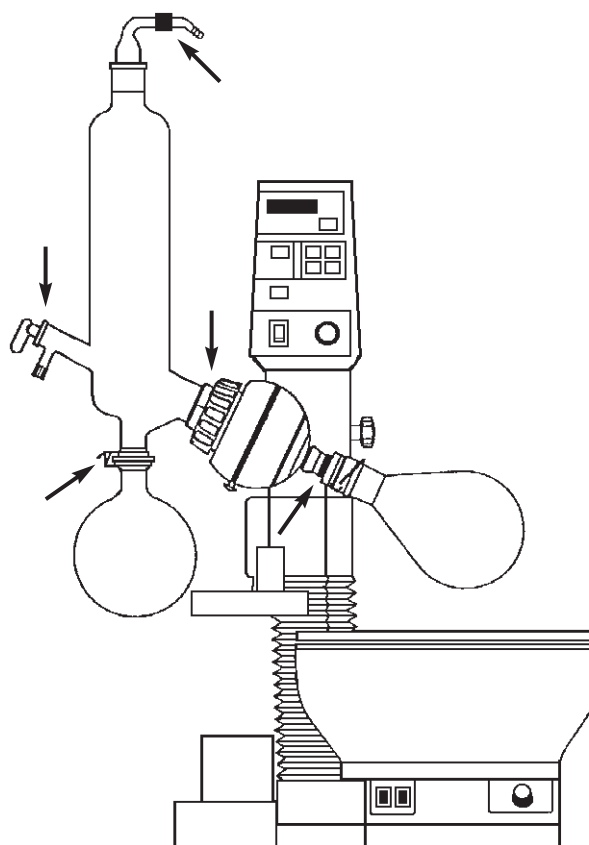

Vacuum control

In order to be able to control the boiling temperature and the conditions of condensation, always a **controlled** vacuum is required. Too often laboratories are still working with leakage air. This is entering the system through slightly opened glass connections or needle valves. Not only does this cause the system pressure to rise, it also results in an immense increase in the flow of unwanted carrier air.

Modern vacuum controllers control the vacuum either by means of a two-way valve in the vacuum hose or through direct switching on or off of the vacuum source. In both cases the required vacuum is achieved by interruption of the vacuum line. Thus creating no unnecessary carrier air flow. Furthermore:

**"Where no vacuum source is in operation,
no solvent will be evacuated."**

Prevention of the chimney effect

Gases and vapors take up far more space than their corresponding amount of liquid. At a pressure of 72 mbar (standard distillation conditions for the Rotavapor[®]), 1 ml water yields 17,500 ml water vapor!

Hence from a small quantity of liquid there is always a thousand- to twenty thousand-fold larger volume of gas formed in the distillation system. By the condensation in the condenser this immense volume of gas is abruptly transformed again into the small volume of liquid. During this process it is possible for vapor velocities at the narrowest points of the glass apparatus to be as high as 150 km/h. Measures must be taken to optimize the movement of vapor inside the condenser (turbulence) in order to prevent direct extraction to the vacuum source

→ chimney effect!

Picture 5:

Chimney effect

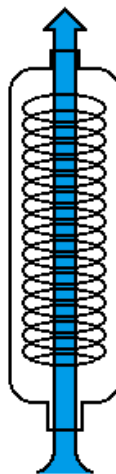

chimney effect



turbulence,
forced condensation

2.3 Physical processes during distillation

Evacuation / filling / distillation

The influence of the carrier air reoccurs when filling and evacuating the distillation apparatus.

The following two diagrams show the critical phase for the loss of solvent. When the air inside the filled distillation apparatus is removed, then the solvent vapors will be carried away as well.

Picture 6:

Evacuation with filled and empty evaporating flask

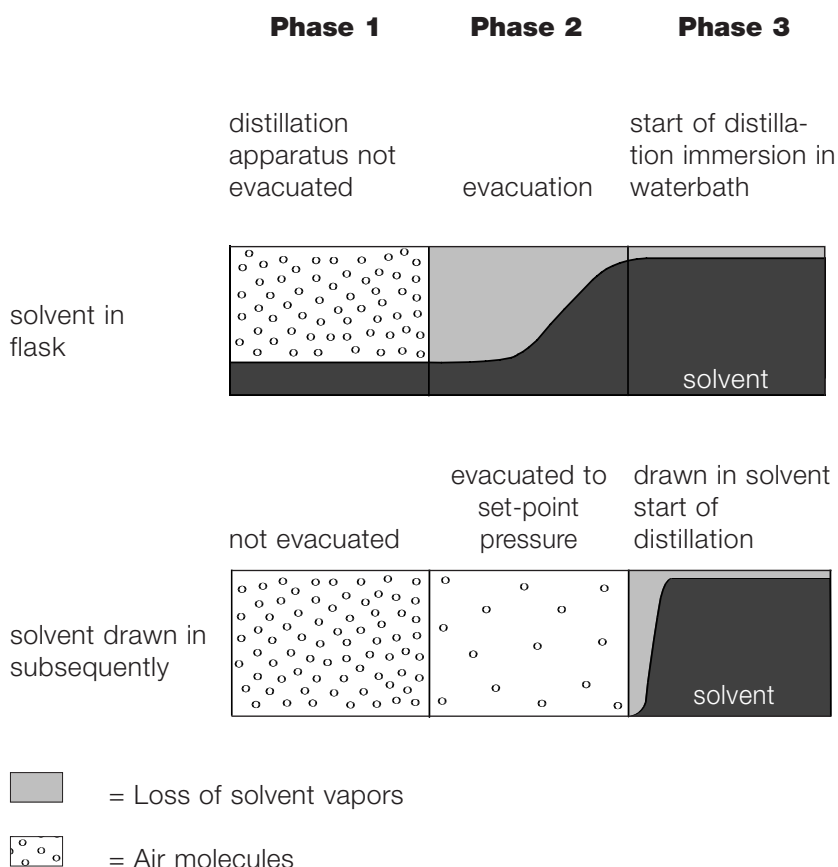

If possible, the distillation system should be evacuated to the set-point pressure first. Afterwards the solvent/product mixture will be drawn into the evaporating flask via the feed cock. Then the evaporating flask will immerse into the heated waterbath. The distillation can start.

Heat-up of flask content and waterbath

A frequent scenario is as follows: The evaporating flask is immersed into the water bath while still in the heat-up phase. Then, because condensation does not take place immediately, the set pressure is “corrected” downwards. This intuitively selected system pressure results immediately in visible condensation on account of the lower boiling point. But as soon as the solvent heats up completely, the condenser will be overloaded. The input thermal energy can no longer be removed completely in the cooling side.

Picture 7:

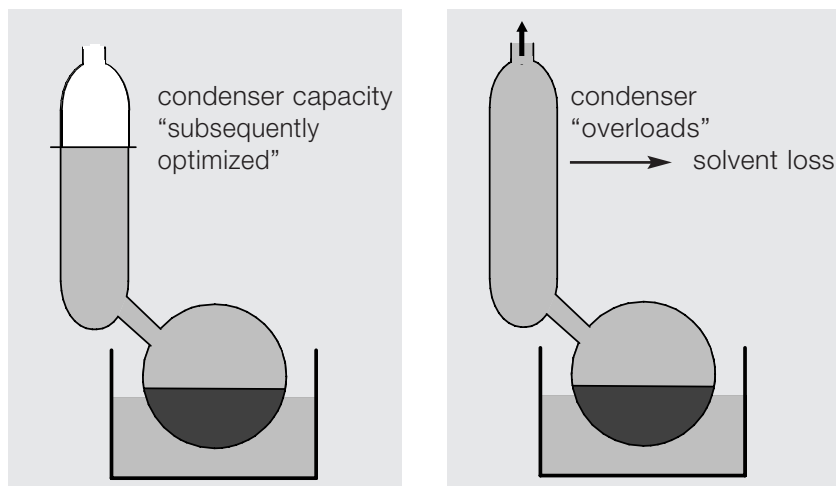
Condenser capacity

waterbath not at set-point temperature

waterbath equals set-point temperature

Mixtures

It frequently happens that the lab technician or chemist does not have to deal with a **single solvent** and a **single solid** (residue). In practice the work often involves mixtures consisting of two or more solvents combined with solids. In these cases it is important to give special consideration to the more volatile solvent. If there are big differences between the boiling points, the separation has to be made in two steps. With ambient temperature and high vacuum the volatile solvent may be distilled in the receiving flask.

Example:

■ Acetone / Water

■ Hexane / Xylene

It is also necessary to take account of Raoult's law which says that the boiling temperature of a mixture rises as the concentration of its low-boiling component decreases.

In other words, the distillation capacity at a set system pressure will drop although the mixture may still contain up to 20% low-boiling agent. The latter will be retained by the binding force of the less volatile substance. In practice this means that the theoretical set-point pressure value will be undershooting by a sizable amount. Therefore it could be separated as much low-boiling component as possible in the first distillation phase. The Δt ratio between the vapor and cooling water temperature must be sufficient, of course, for the condensation ($> 5^\circ\text{C}$). After the low-boiling component has been removed it is then possible without further problems to distill the higher-boiling components of the mixture in a single cycle.

Example:**Acetone/water mixture**

1st phase "acetone":	Starting at 556 mbar and dropping to 350 mbar. Change flask.
2nd phase "water":	Starting at 350 mbar via 72 mbar (water), dropping to 40 mbar

Boiling point: Acetone at 556 mbar: 40°C
 Acetone at 72 mbar: approx. -1°C

Since this process requires a person to attend the apparatus virtually at all time, Büchi AG has developed the Vacuum Controller B-721. The B-721 maintains the desired vacuum during the entire distillation and thus makes possible a rational and efficient process cycle. In addition to the proven manual operation, automatic distillation is also possible with a Büchi Rotavapor[®]. This is carried out together with the vapor temperature probe. Pressure conditions are determined automatically in correspondence with the respective solvent and optimized during the entire distillation.

Evaporation to dry

Evaporation to dry sometimes requests working with system pressures that are far below normal conditions (Raoult's law). To solve the resulting problems of condensation in an environmentally friendly way the following systems are used in the laboratory:

- Aftercondenser on the pressure side
 - Cold trap on the vacuum side (- 70°C)
 - Wet gas scrubber
-

3**Summary**

Good ecology is practiced daily even on “small” rotary evaporators. With exact observance of physical processes, a consistent system set-up and selection of the right pressure and temperature parameters there is no difficulty in operating distillation apparatus with solvent recovery rates of over 99%.

Summarized steps to the successful distillation of solvent**■ A consistent set-up**

- Rotary evaporator with vacuum controller / Wouff bottle / Check valve / Controlled, interruptible vacuum source / Aftercondenser
- Seal tightness of < 2mbar/min (carrier air problem)
- Prevention of the chimney effect

■ Selection of suitable pressure and temperature conditions

- Energy compensation (rule of 20/40/60°C)
- Cooling temperature/vapor temperature (rule of Δt 20°C)
- A sufficiently large cooling surface

■ Observance of physical conditions

- Evacuate in the empty stat, draw in mixtures through a feed cock
 - Set pressure in accordance with tabular values, not by intuition
 - Heat the waterbath to set-point temperature prior to distillation utilization of condenser capacity)
 - Observe Raoult's law with mixtures and evaporation to dry
-

Annex

Dependence of boiling point (T) and system pressure (p)

(A choice of some common solvent)

If the selected solvent is not on the following table, choose an example, which is close to the boiling point and make a similar curve. The chosen boiling point is obtained.

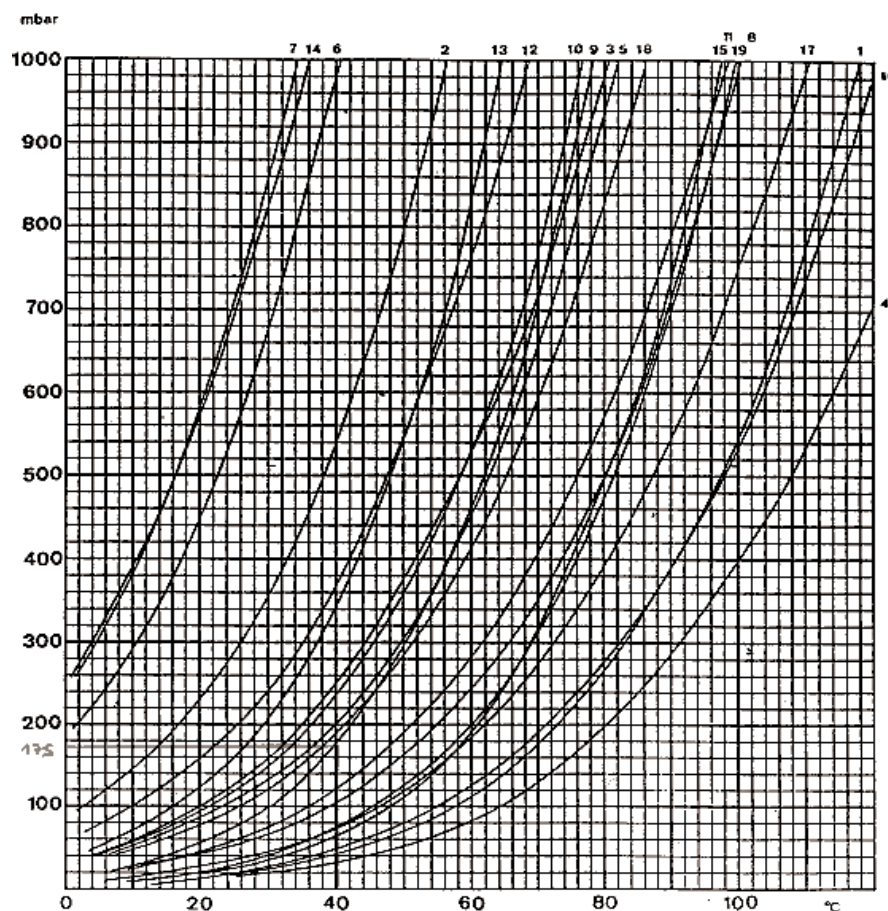
**Legend:**

1	Acetic acid	118°C	10	Ethylacetate	77°C
2	Acetone	56°C	11	Heptane	98°C
3	Benzene	80°C	12	Hexane	69°C
4	Chlorobenzene	132°C	13	Methanol	65°C
5	1.2-Dichloroethane	84°C	14	Pentane	36°C
6	Dichloromethane	40°C	15	n-Propyl-alcohol	97°C
7	Diethylether	35°C	16	Tetrachloroethylene	121°C
8	Dioxane	101°C	17	Toluene	111°C
9	Ethanol	79°C	18	Trichloroethylene	87°C
			19	Water	100°C

BÜCHI

Labortechnik AG

P.O. Box
 CH-9230 Flawil
 Switzerland
 Phone 071 394 63 63
 Fax 071 394 65 65
<http://www.buchi.com>
 e-mail: sales@buchi.com

